

# Data Sheet



Article number: 12522800230500  
Description: KLEE-coil 522 800 230.500  
M3 Stainless 1.4305

## Measures

---

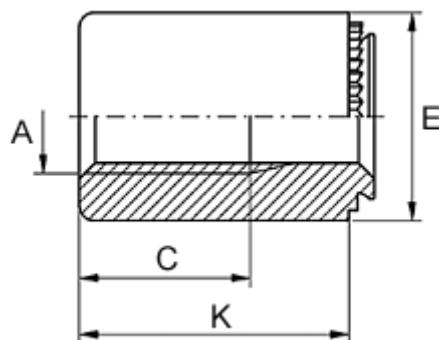

Female thread A	= M3
Height K	= 22
Min distance to edge	= 4.0
Outer diameter E	= 7
Plate thickness	= 1.5 to 2.3
Recommended bore diameter +0.05	= 5.00
Thread length	= 8.0